



Davis Aircraft Products Co., Inc.

**Introduction  
to  
Davis Aircraft Products Co. Inc.**



Davis Aircraft Products Co., Inc.

## Facilities

- 2 Locations totaling over 55,000 sq.ft.
  - Bohemia, NY Headquarters
  - FAA Repair Station & Light Manufacturing



Davis Aircraft Products Co., Inc.

## The Company

- Established in 1951
- 3 Generations in the Aircraft Industry
- 160 Employees
- 1000's of stock Assemblies
- International Network of Sales Associates
- Currently 70% Military- 30%Commercial Sales



Davis Aircraft Products Co., Inc.

## About Us

Our manufacturing facilities are located in New York. We offer a broad range of aviation related assemblies. An engineering-based company, Davis develops customized solutions to meet demanding commercial and military requirements. Davis has been designing and manufacturing safety tie-down and cargo control products since the 1950s and is an accepted standard in the aviation industry. In addition to providing products for standard applications, "rapid" custom design and engineering solutions are also available.



Davis Aircraft Products Co., Inc.

## About Us Cont.

Some of the company's specialized engineered products include, an energy attenuating cargo tiedown system designed for use in the Boeing-Bell V-22 Osprey. This system incorporates attenuator elements which absorb crash energy by means of permanent deformation, and thus protect aircraft structure & cargo from the crash loads. The Advanced Cargo Tiedown System (ACATS) uses an innovative aramid webbing material which combines the high strength (36,000 lb, 14,170 kg) and low elongation of chain systems, that reduces weight and eases handling of strap systems. We offer several helicopter blade folding kits for air transport.



Davis Aircraft Products Co., Inc.

## About Us Cont.

Davis' hardware products include chain tensioners, buckles, hooks, rings, studs, floor plates, web & net assemblies, double wall fuel lines, ballistic, thermal & acoustic blankets. Seat belts and harness' are certified to TSO-C22 and TSO-C114 and include 4 and 5 point rotary buckles and 16g inertia reel systems. Customized plating and logos are available together with a choice of over 100 web colors.



Davis Aircraft Products Co., Inc.

# Manufacturing and Production Capabilities



Davis Aircraft Products Co., Inc.

## Manufacturing Methods

- CNC Machining
- Water Jet Cutting
- Stamping
- Light-Medium Assembly
- CNC Sewing
- Min/Max & Kitting
- CNC Tube Bending & Fabrication

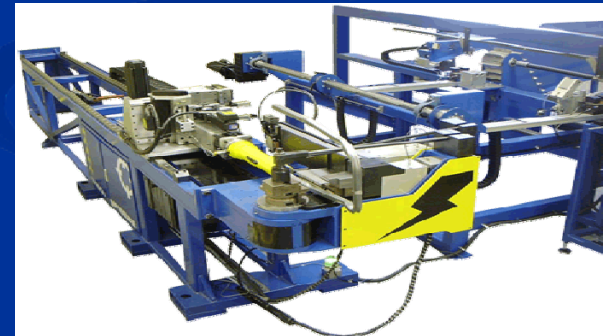



**DAVIS**

Davis Aircraft Products Co., Inc.

## Some Of Our Quality Manufactured Parts

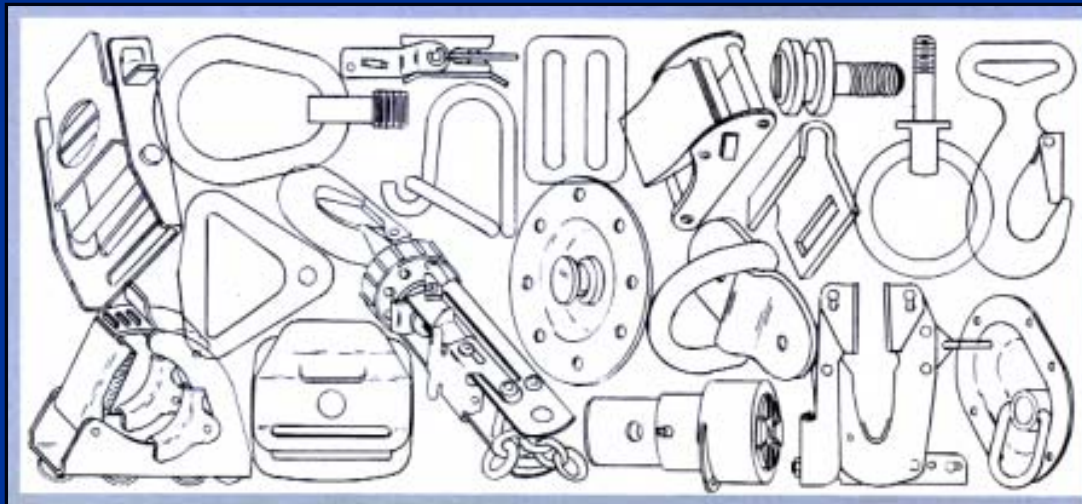

**DAVIS**

Davis Aircraft Products Co., Inc.

## More Of Our Quality Manufactured Parts

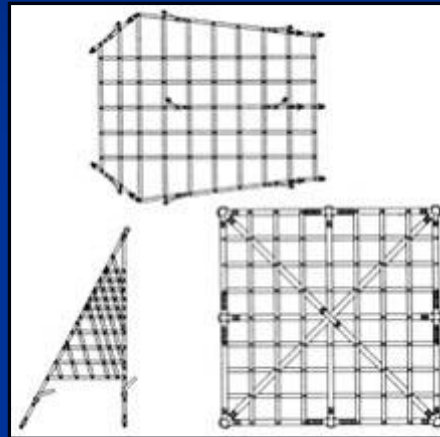

Machined From Solid Billet

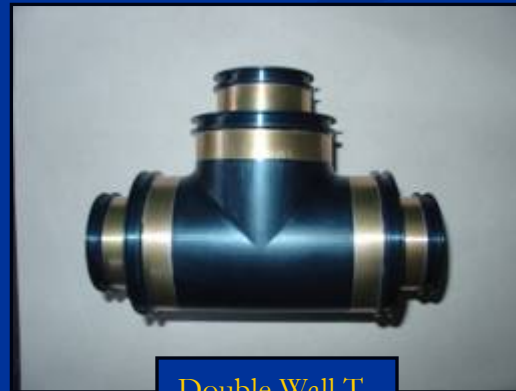

Double Wall T

**DAVIS**

Davis Aircraft Products Co., Inc.

## Slings and Cargo Nets





Davis Aircraft Products Co., Inc.

## Seat Belts and Harnesses



Davis Aircraft Products Co., Inc.



Davis Aircraft Products Co., Inc.

# Litter Brackets and Litter Strap Assemblies

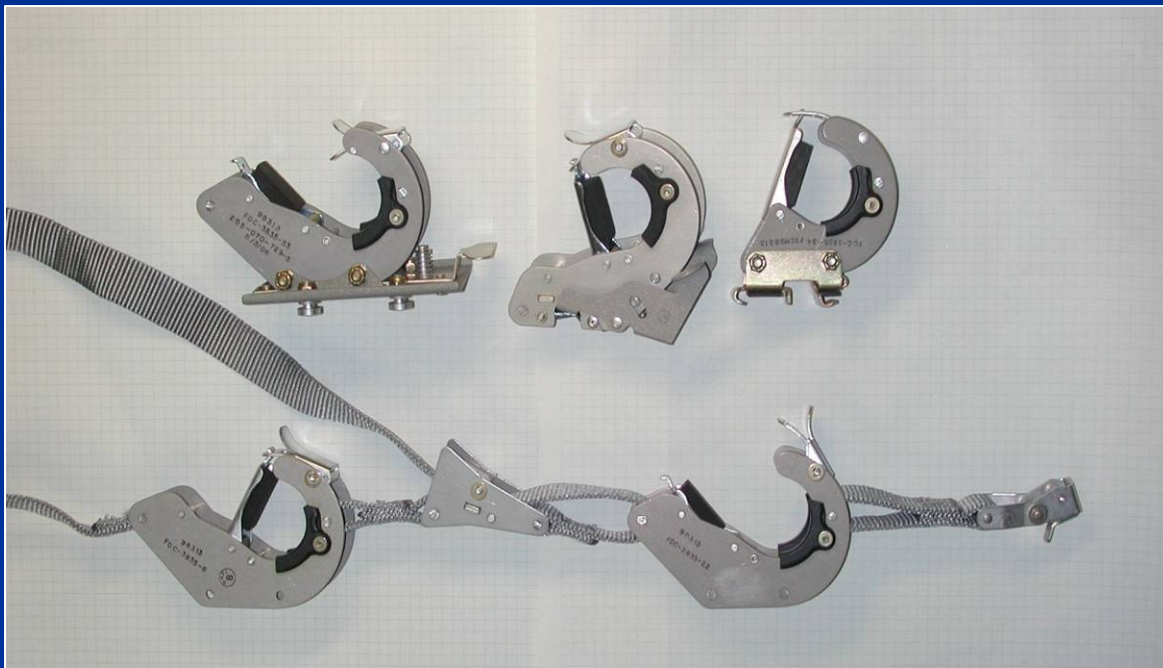

Davis Aircraft Products Co., Inc.

**DAVIS**

Davis Aircraft Products Co., Inc.

## Strap Assemblies and Tie Downs

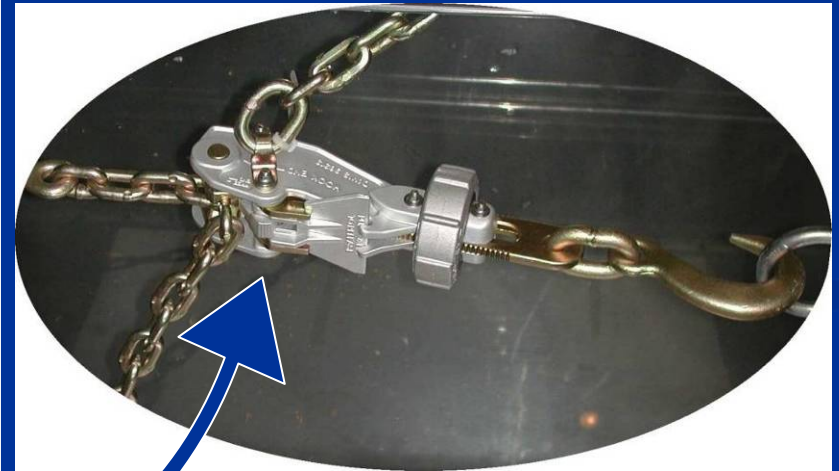

**Chain Gear: CGU-4/E • MB-1 • CGU-3/E • MB-2 • TD-1B**

Davis Aircraft Products Co., Inc.



Davis Aircraft Products Co., Inc.

## Strap Assemblies and Tie Downs





Davis Aircraft Products Co., Inc.

## Strap Assemblies and Tie Downs

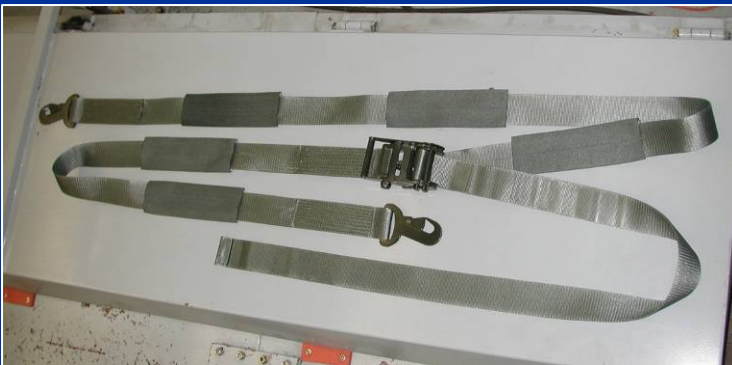

Davis Aircraft Products Co., Inc.





Davis Aircraft Products Co., Inc.

# Product Overview

## Blade Fold Kits

- AH-64 APACHE
- SH-60 SEAHAWK
- CH-148 (S-92) Cyclone
- UH-60 BLACKHAWK
- S-76 SPIRIT
- EH-101 MERLIN
- CH-47 CHINOOK
- MI-17

**DAVIS**

Davis Aircraft Products Co., Inc.

## Helicopter Rotor Blade Restraints



**Blade Fold Kits**

Davis Aircraft Products Co., Inc.

**DAVIS**

Davis Aircraft Products Co., Inc.

## Helicopter Rotor Blade Restraints

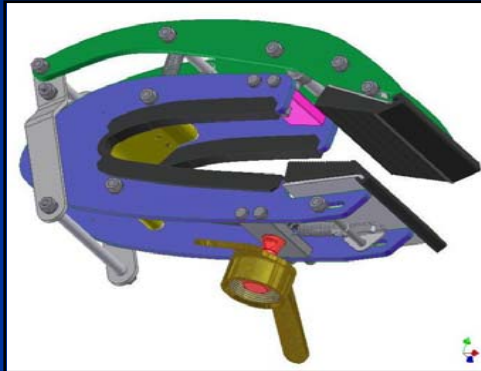

**Blade Clamp Assemblies**

Davis Aircraft Products Co., Inc.

**DAVIS**

Davis Aircraft Products Co., Inc.

## Helicopter Rotor Blade Restraints

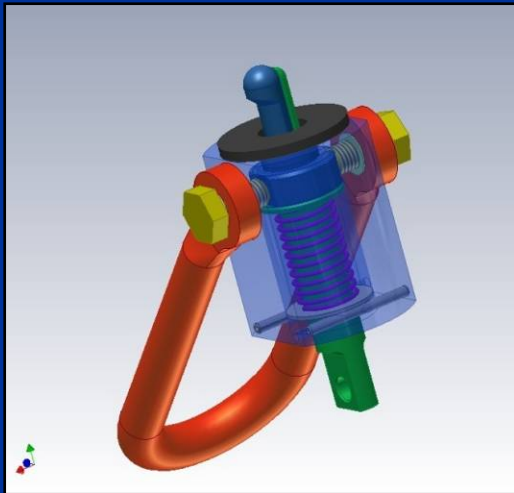

**CH-47 Main Rotor Blade Interlock**

Davis Aircraft Products Co., Inc.

**DAVIS**

Davis Aircraft Products Co., Inc.

## Helicopter Rotor Blade Restraints



**S-76 Main Rotor Blade Fold Kit**

Davis Aircraft Products Co., Inc.



Davis Aircraft Products Co., Inc.

## Helicopter Rotor Blade Restraints



**UH60A-L and UH60M Blade Fold Kit**

October 2010

Davis Aircraft Products Co., Inc.

**DAVIS**

Davis Aircraft Products Co., Inc.

## Helicopter Rotor Blade Restraints



**CH148 Main Rotor Blade Fold Kit**

Davis Aircraft Products Co., Inc.



**DAVIS**

Davis Aircraft Products Co., Inc.

## Helicopter Rotor Blade Restraints



**CH-148 Lifting Clamp**

Davis Aircraft Products Co., Inc.

**DAVIS**

Davis Aircraft Products Co., Inc.

## Helicopter Rotor Blade Restraints



**SH-60 Main Rotor Blade Fold Kit**

Davis Aircraft Products Co., Inc.

**DAVIS**

Davis Aircraft Products Co., Inc.

## Helicopter Rotor Blade Restraints



**EH101 Blade Restraint Fittings**

Davis Aircraft Products Co., Inc.



Davis Aircraft Products Co., Inc.

## Helicopter Rotor Blade Restraints



**S-92 Blade Fold Trolley**

Davis Aircraft Products Co., Inc.

## AH-64 Main Rotor Blade Fold Kit

- RAPID DEPLOYMENT
- SEVEN PERSON TEAM
- BLADE UNFOLD 45 MINUTES MAX TIME LIMIT – DEMONSTRATED AT 23 MINUTES
- COLD WEATHER GEAR
- MOPPS GEAR LEVEL 4
- FLIGHT TEST NOT REQUIRED

**Facts**

## AH-64 Main Rotor Blade Fold Kit

- FOLD/UNFOLD IN 40 MPH WIND
- PARK IN 70 MPH WIND
- SNOW LOADING 20 LB/FT<sup>2</sup>
- NO MODIFICATIONS TO AIRCRAFT

**Facts Cont.**

## AH-64 Main Rotor Blade Fold Kit

- AIR TRANSPORTABILITY (C-5 SIX-PACK)

### LOADS:

- 2.0G VERTICAL UP
- 4.5G VERTICAL DOWN
- 3.0G FORWARD
- 1.5G AFT
- 1.5G LATERAL

**System Requirements**

**DAVIS**

Davis Aircraft Products Co., Inc.

## AH-64 Main Rotor Blade Fold Kit



Davis Aircraft Products Co., Inc.





Davis Aircraft Products Co., Inc.

## AH-64 Main Rotor Blade Fold Kit



Tail Rack Assemblies

Davis Aircraft Products Co., Inc.

**DAVIS**

Davis Aircraft Products Co., Inc.

## AH-64 Main Rotor Blade Fold Kit



**Standoff Fitting, Stop Plate Assembly, & Handle Pins**

Davis Aircraft Products Co., Inc.

**DAVIS**

Davis Aircraft Products Co., Inc.

## AH-64 Main Rotor Blade Fold Kit

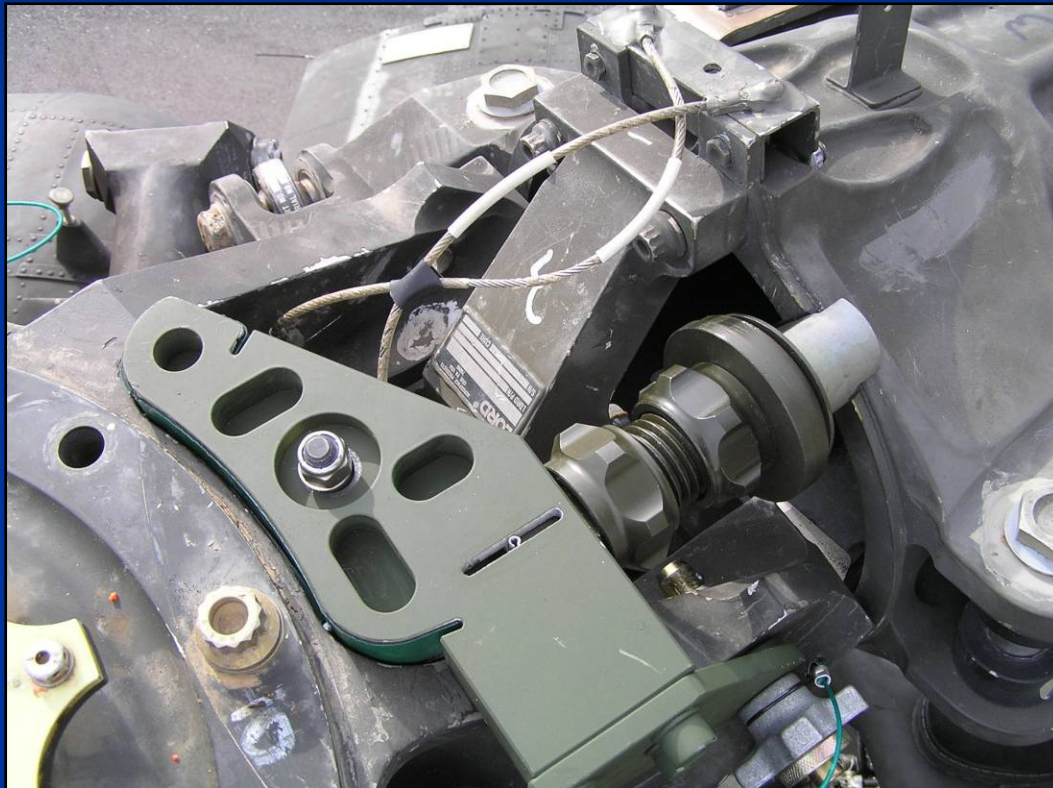

**Flap Lock Assembly**

Davis Aircraft Products Co., Inc.

**DAVIS**

Davis Aircraft Products Co., Inc.

## AH-64 Main Rotor Blade Fold Kit



**Transfer Poles and Straps Harnesses**

Davis Aircraft Products Co., Inc.

**DAVIS**

Davis Aircraft Products Co., Inc.

## AH-64 Main Rotor Blade Fold Kit

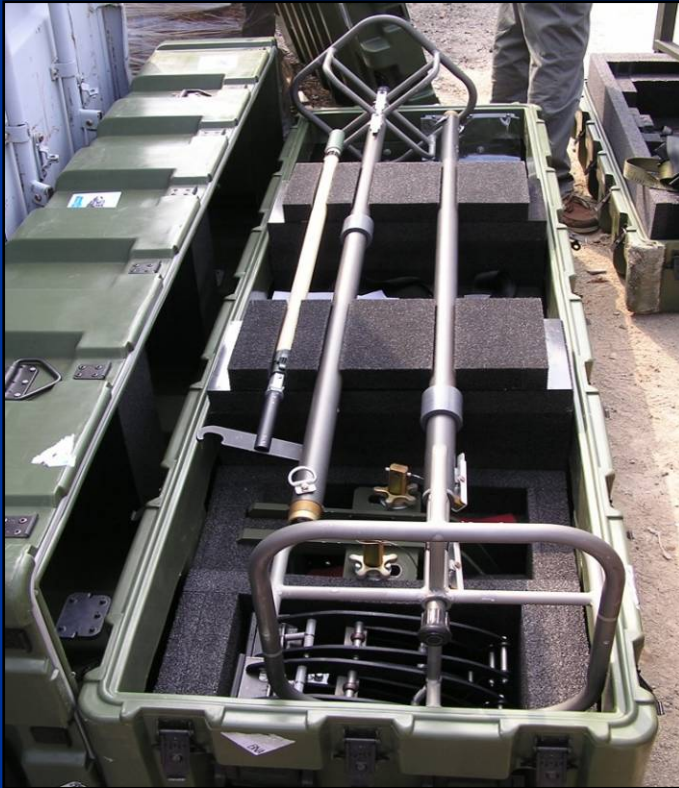

**Containers**

Davis Aircraft Products Co., Inc.

**DAVIS**

Davis Aircraft Products Co., Inc.

## AH-64 Main Rotor Blade Fold Kit



**Scan of Aircraft**

Davis Aircraft Products Co., Inc.



Davis Aircraft Products Co., Inc.

# Research and Development



Davis Aircraft Products Co., Inc.

## Equipment

- Bystronic 3015 Byjet Water Jet 5'x10' 55,000psi
- Unison "Breeze" 7 Axis Full Electric Tube Bending 45mm
- KSL CNC Sewing System 1000mm x 800mm
- Makino a61 Horizontal Mill 2007 Haas Mini Mill
- Mori Seiki ZT1000Y CNC Machining Center
- Elumatec SBZ 122/30 4-axis tube Machining Center
- Up to 80 Ton OBI Press Department
- Textile Fabrication Cut/Sew/Assemble
- Wire & Synthetic Rope splicing/assembly
- Stratasys Dimension Rapid Prototype Machine (ABS Plastic)
- Laser/Dot Peen Part Making





Davis Aircraft Products Co., Inc.

## Software

- 🏠 CAD: CATIA V5, AutoDesk Inventor
- 🏠 CAM: Gibbs Cam / Master Cam
- 🏠 FEA Algor, CATIA
- 🏠 PLM: AutoDesk Vault / Product Stream
- 🏠 MRP: Pentagon 2000SQL

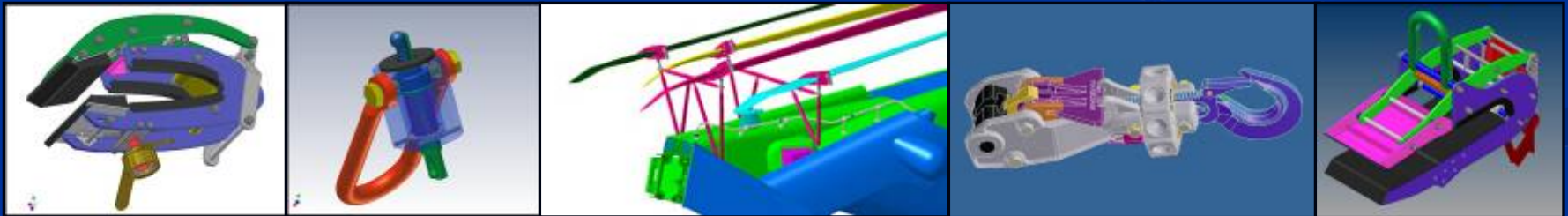



Davis Aircraft Products Co., Inc.

## Designing

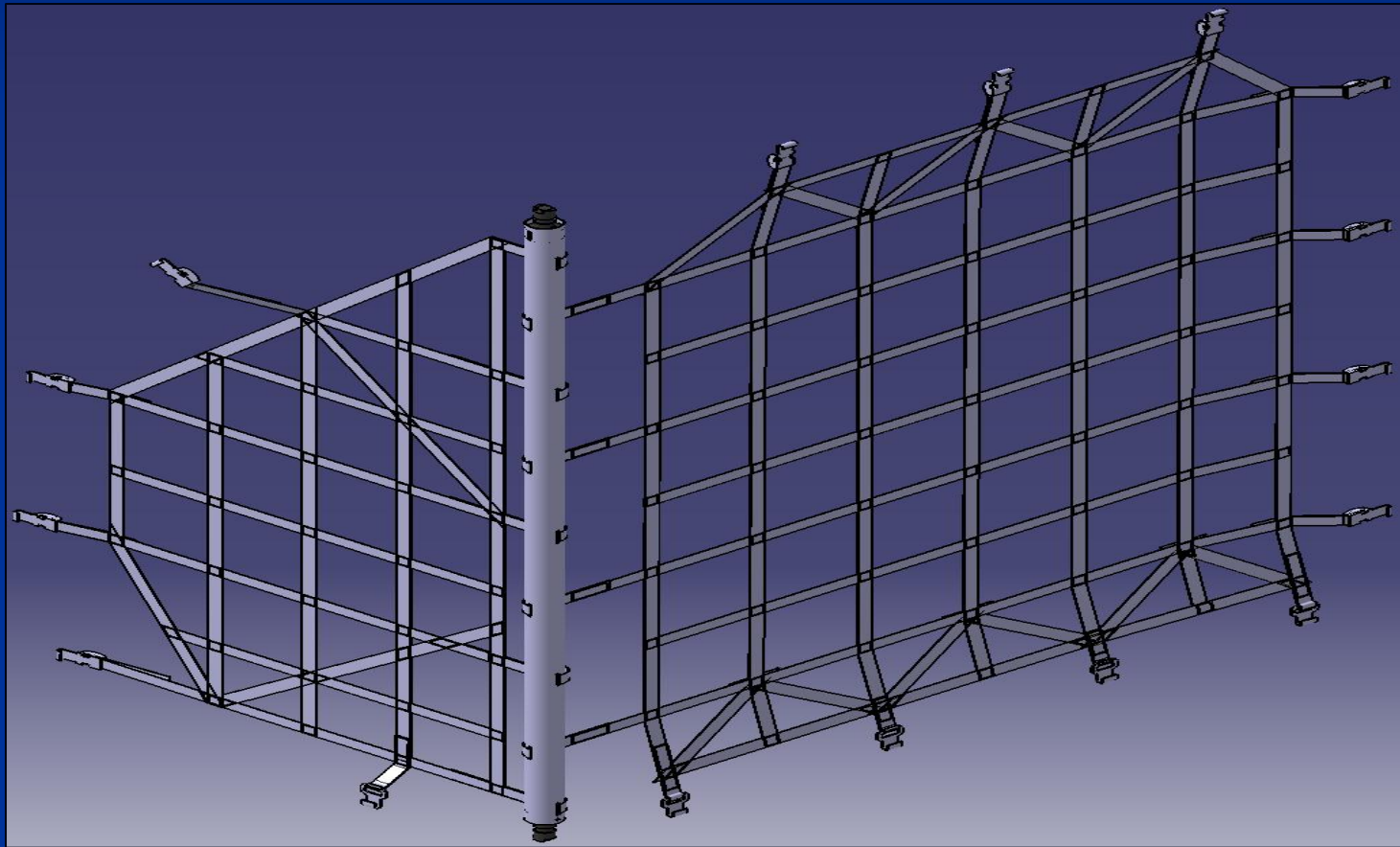



Davis Aircraft Products Co., Inc.

# Designing

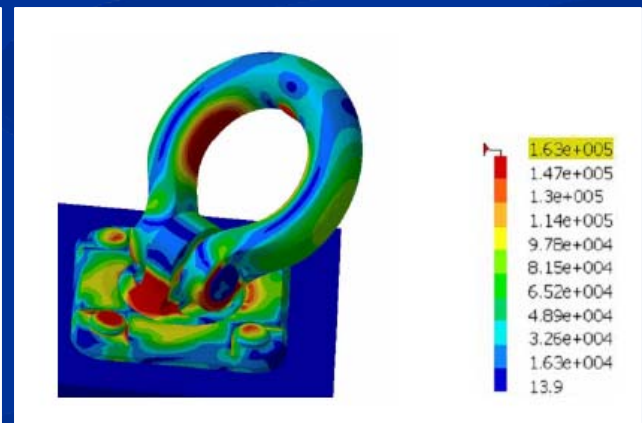
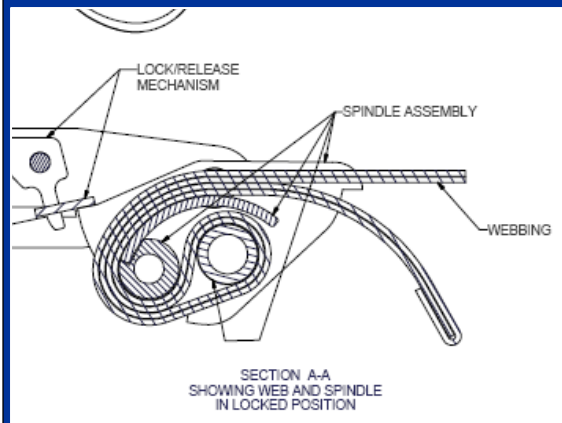
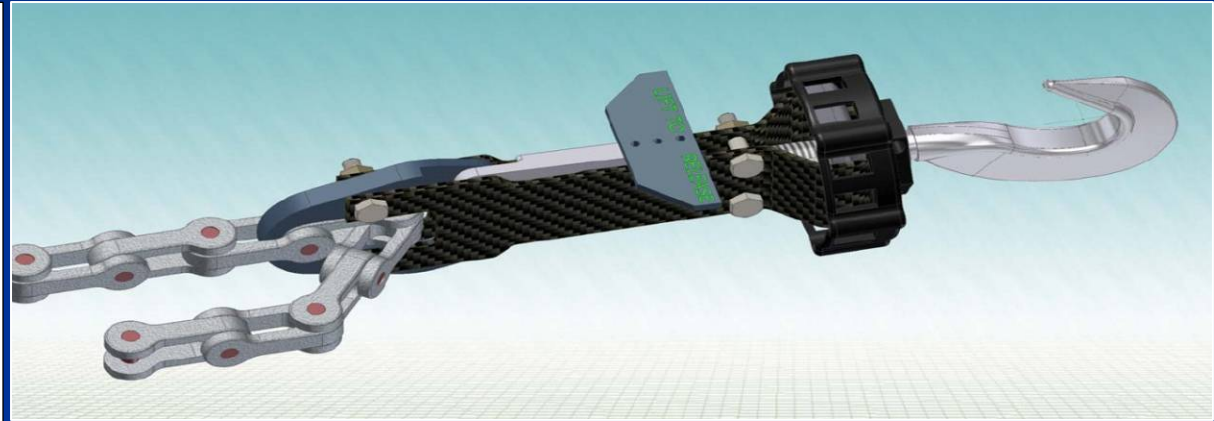



Davis Aircraft Products Co., Inc.

## Inspection and Test Capabilities

- 4 tensile machines to max. 50 ton/20' bed length
- Torso Body Block for FAA TSO-C114
- Zeiss Vista Coordinate Measurement Machine
- Multi Systems Tube CMM
- Systems Scientific Labs plating detector # 520L
- Oxford Non-Destructive plating thickness CMI 233
- EQUOTIP Portable Hardness Tester



Davis Aircraft Products Co., Inc.

# Testing

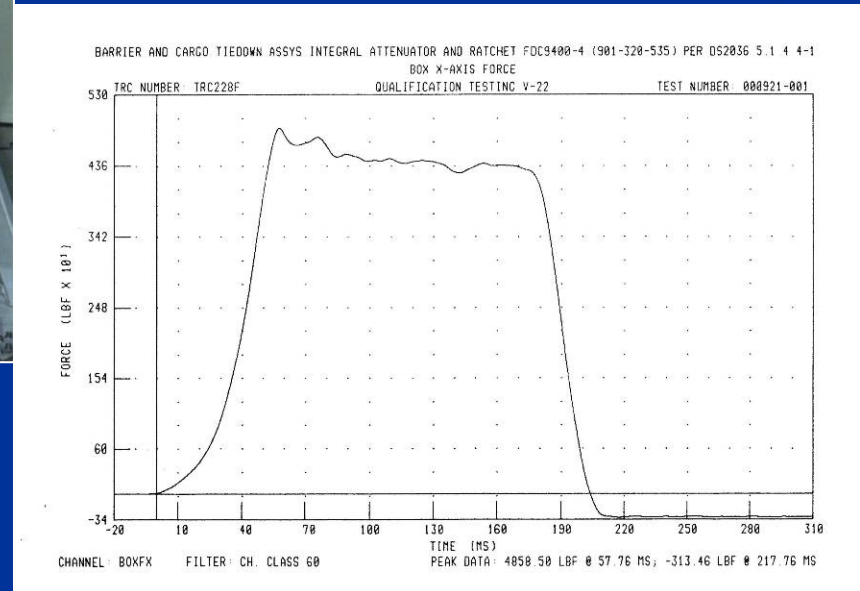
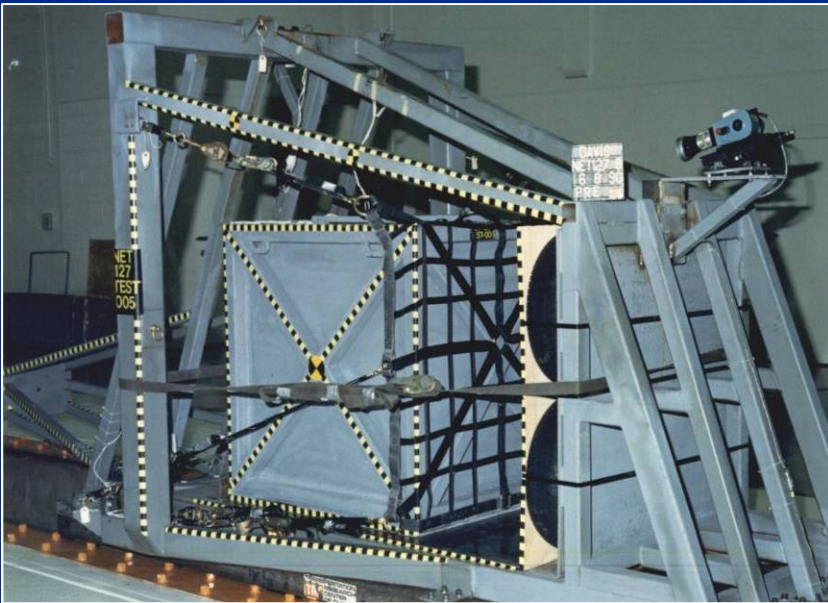



Davis Aircraft Products Co., Inc.

## Testing

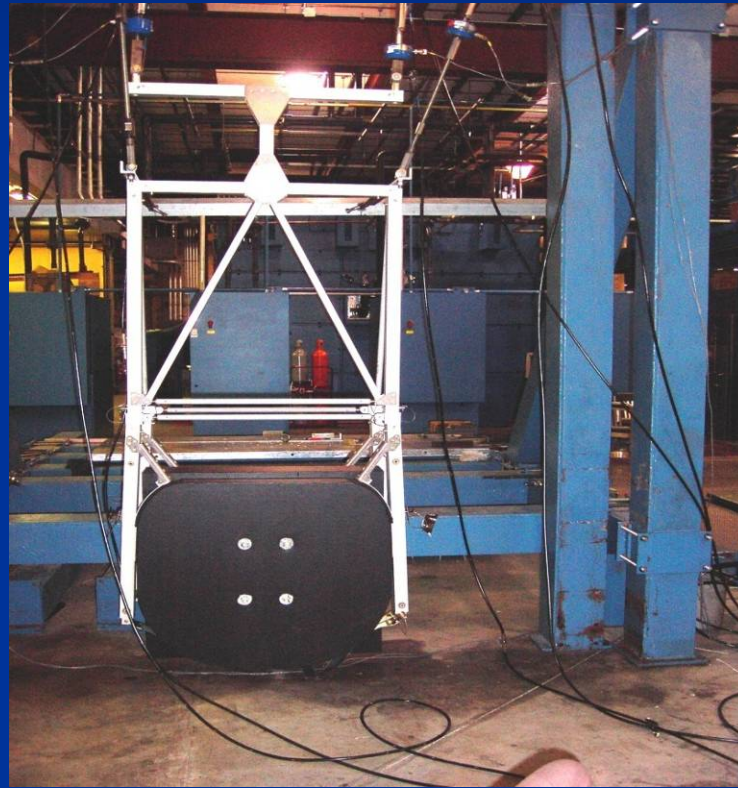

**Tail Rack Assembly Test**

Davis Aircraft Products Co., Inc.

**DAVIS**

Davis Aircraft Products Co., Inc.

## Testing

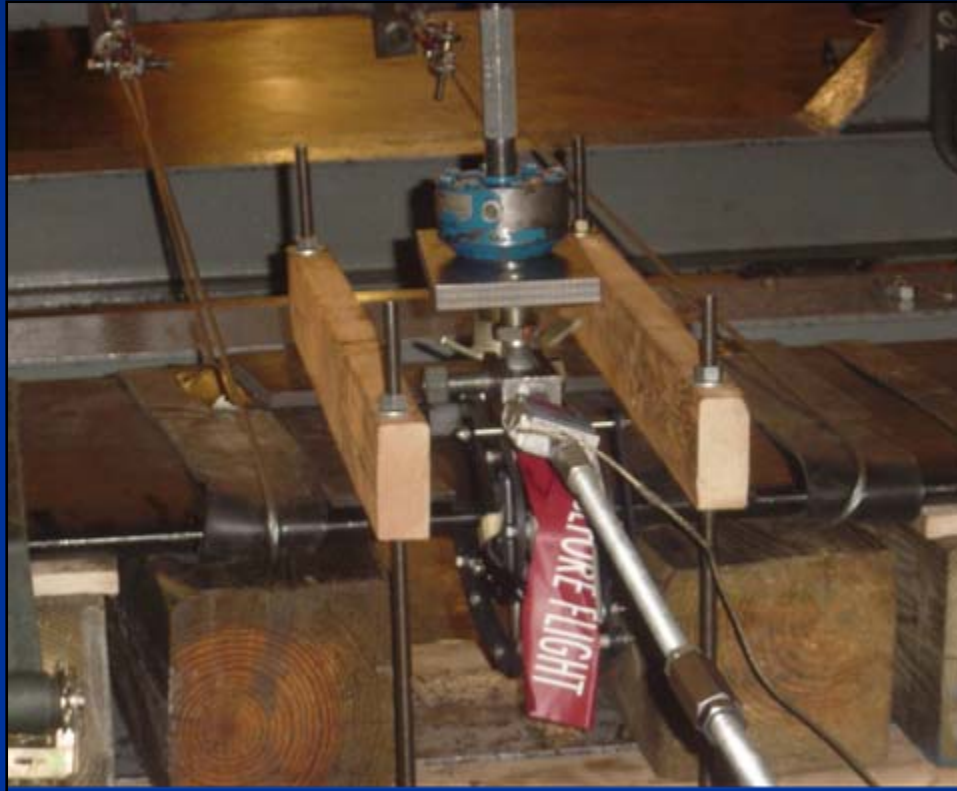

**Blade Clamp Test**

Davis Aircraft Products Co., Inc.

**DAVIS**

Davis Aircraft Products Co., Inc.

## Testing

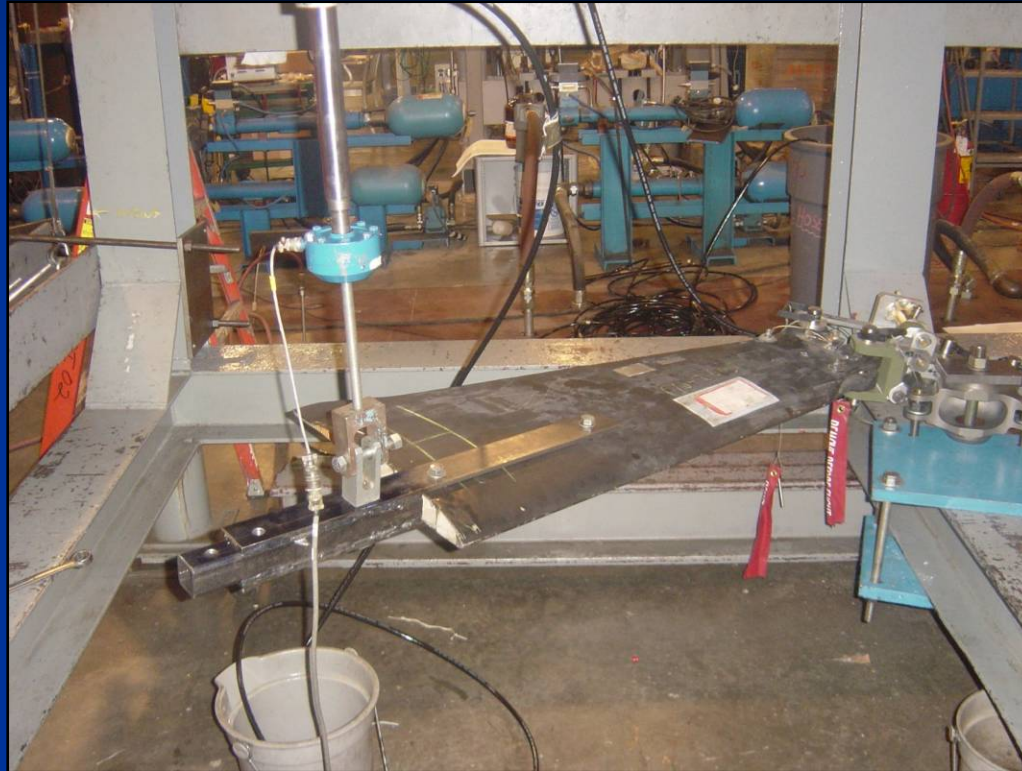

**Standoff Fitting and Stop Plate Assembly Test**

Davis Aircraft Products Co., Inc.





Davis Aircraft Products Co., Inc.

# Quality Control and Milestones



Davis Aircraft Products Co., Inc.

## Quality Assurance

- ✈ ISO 9001: 2008 and AS9100 REV. B Certified
- ✈ NYSTAR LEAN Transformation Training Program
- ✈ Risk Management for AS9100 Rev. C Training



## Supplier Quality Ratings

- Sikorsky > 98%
- Lockheed Martin Aero 100%
- Boeing Co 100%
- Goodrich Corp 100%
- Biodex 100%
- Helicomb International 100%
- DSCC Columbus (Government) 99.6%



Davis Aircraft Products Co., Inc.

## Recent Accomplishments

- \$5 Million in Capitol Investment since 2004
- 300% increase in sales since 2003
- Major System R&D, Qualifications:
  - Boeing AH-64 Main Rotor Blade Fold Kit AED approved
  - Bell ARH 100 knot Rotor Blade Restraint
  - Sikorsky S-92/CH-148 Main Rotor Blade & Tail Pylon Fold Kit
- New Market Penetration :
  - Contract Manufacture
  - Patented Double Wall Fuel Line Bombardier, Cessna, Embraer, Mitsubishi, AIDC



Davis Aircraft Products Co., Inc.

## Large Volume Customers

- AM General (over 100 Pn's HMMWV)
- Boeing (CH-47 Troop Seat Comp, Litter Straps, Interior Panels)
- Defense Logistics Agency
- Southwest Airlines Seat Belts, Straps
- Sikorsky Min-Max
- BAE Survivability Systems



Davis Aircraft Products Co., Inc.

## What Davis has offered its customers for 60 years

- A strategic innovation partner to help design, certify and economically manufacture new and improved systems.
- Proven design track record with V-22, C-17, Apache PMO, Sikorsky UH-60, S-92, CH-148, AM-General HMMWV
- Small Women Owned Business/Small DV Owned with EFMC Joint Venture Participation

## Contact Us

- Davis Aircraft Products Co., Inc.
- 1150 Walnut Ave. - Bohemia, NY 11716
- <http://www.davisaircraftproducts.com>
- Phone: 631-563-1500
- Fax: 631-563-1117
- E-Mail: [dapisouth@aol.com](mailto:dapisouth@aol.com)
- Jill Davis, CEO



Davis Aircraft Products Co., Inc.

**Thank You**